



Hearth Products Controls Co

www.HPCfire.com

Electronic Ignition Flame Control System

Safety Manual

Installation & Operation Instructions

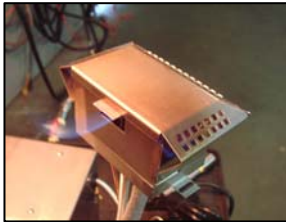

Installation

We suggest that our products be installed by professionals that are locally licensed by the authority having jurisdiction in gas piping.

Service



We suggest that our products be serviced by a professional certified in the US by the National Fireplace Institute (NFI) as NFI Gas Specialists.

⚠ WARNING: FOR OUTDOOR USE ONLY

⚠ WARNING

•Improper installation, adjustment, alteration, service, or maintenance can cause injury or property damage. Read the installation, operating, and maintenance instructions thoroughly before installing or servicing this equipment.

⚠ WARNING

- Do not store or use gasoline or other flammable vapors and liquids in vicinity of this or any other appliance.
- An LP-cylinder not connected for use shall not be stored in the vicinity of this or any other appliance.

⚠ DANGER

If you smell gas:

- 1) Shut off gas to appliance.
- 2) Extinguish any open flame.
- 3) If odor continues, keep away from appliance and immediately call gas supplier or fire department.

**INSTALLER: Leave this manual with the appliance.
CONSUMER: Retain this manual for future reference.**

Index:

- 1) General Information
- 2) Selecting the Location
- 3) Construction of Enclosure
- 4) Installation of Fire Pit
- 5) Media

Product Specific Information

- 6) Parts
- 7) Installation of Flame Control System
- 8) Fire Pit Operation
- 9) Maintenance
- 10) Troubleshooting
- 11) Replacement Parts
- 12) Warranty

1) General Information

Instructions are also available at HPCfire.com

Please carefully follow the instructions in this manual to prevent personal injury or property loss. Instructions are updated as needed. It is the installer's responsibility to periodically review instruction for applicable updates.

The steps listed as:

WARNINGS Contains information critical to the safe installation and operation of the fire-pit.

WARRANTY REQUIREMENT Must be strictly followed to qualify for product warranty. Warranty will be void if not followed.

IMPORTANT Are notes and insights to help ensure product satisfaction and serviceability.

WARNING: It is the installers responsibility to ensure a safe installation and to educate the end user as to proper operation. Leave this manual with the end user.

WARNING: Never alter product or configuration in any way.

WARNING: FOR REMOTE CONTROL USE: For Electronic Ignition Models to prevent accidental start-up from unwanted RF signals it is the responsibility of the end user to turn off power to electric outlet for the remote control receiver when the fire-pit is not in use via wall switch or breaker.

WARNING: We suggest that our products be installed by professionals that are locally licensed by the authority having jurisdiction in gas piping. We suggest that our products be serviced annually by a professional certified in the US by the National Fireplace Institute (NFI) as NFI Gas Specialists or in Canada by WETT (Wood Energy Technical Training). Installer must follow all instructions carefully to ensure proper performance and safety. Hearth Products Controls Company is not responsible for your actions.

WARNING: Product is not intended to be a starter for wood or any other combustibles.

WARNING: It is the responsibility of the installer to follow ALL LOCAL CODES concerning the installation and operation of the fire pit. In the absence of local codes, please follow:

- Fixed piping system: The *National Fuel Gas Code, ANSI Z223.1/NFPA 54* or *International Fuel Gas Code*.
- Electrical ground: The *National Electrical Code, ANSI/NFPA 70*.

WARNING: Only use gas/fuel type specified for this fire pit see label on the fire pit control Box. Verify correct gas/fuel type and pressure. Never use an alternative fuel to include bio-fuel, ethanol, lighter fluid or any other fuel.

Gas pressure and type should be checked prior to use and installation.

- Natural Gas Fire Pit:
Supply Pressure: Minimum: 3.5" W.C.; Maximum: 7.0" W.C.
Outlet Pressure: 3.5" W.C.
- LP Gas:
Supply Pressure: Minimum: 8.0" W.C.; Maximum: 11.0" W.C.
Outlet Pressure: 10.0" W.C

2) Selecting the Location

WARNING: All fire pits, match lit kits, spark ignition, safety pilot and electronic ignition systems are designed and intended for outdoor use only.

WARNING: For electronic ignition models there must be an electrical shut off (wall switch or breaker) on the exterior of the fire pit or on adjacent wall to allow for emergency shutdown and maintenance.

WARNING: All fire pits must have a gas shutoff on the outside of the exterior of the fire pit to allow for emergency shut off and maintenance. The gas shutoff should not be used to adjust flame height.

WARNING: Select a location where the fire pit can be attended during operation. Never leave an operating fire pit unattended or by someone not familiar with its operation or emergency shut off locations.

WARNING: Both children and adults should be alerted to the hazards of high surface temperatures and should stay away to avoid burns and clothing ignition.

WARNING: Young children should be carefully supervised when they are in the area of fire pit.

WARNING: Clothing or other flammable materials should not be placed on or near fire pit.

WARNING: Fire pits create very high temperatures - Combustibles must be located far enough away that there is no risk of ignition.

IMPORTANT: It is recommended that material such as granite, marble or other dense stone be kept away from heat and especially flame due to risk of cracking. Manufacturer is not responsible for damage.

Fire Pit Clearances – See Figures 1 and 2 On Last Pages

Under Valve Box When Applicable	2” For Drainage
Sides Surrounding Fire Pit	48” From Structure or Combustibles
Overhead Clearance	Nothing Over Head

- Select a location with good drainage.
- Choose a location that allows easy access for installation and maintenance of the fire pit.
- Pick a location that allows sufficient horizontal room to enjoy the fire pit while allowing a safe distance from the heat and flame.

3) Construction of the Enclosure

WARNING: For electronic ignition models there must be an electrical shut off (wall switch or breaker) on the exterior of the fire pit or on adjacent wall to allow for emergency shutdown and maintenance. Verify correct 110VAC, 1 amp or 24VAC 4 amp Supply.

WARNING: For 24V systems a Class II, 24VAC, 4 amps (14 gauge wire) must be supplied to the fire pit and able to be switched on and off from a remote location to allow for easy access or emergency.

WARNING: All fire pits must have a gas shutoff on the outside of the exterior of the fire pit to allow for emergency shut off and maintenance. The gas shutoff should not be used to adjust flame height.

WARNING: Always use proper materials and construction for gas supply, power and enclosure.

WARNING: The enclosure must incorporate 1 vent on at least two opposing sides (2 vents total) at a minimum size of 18 sq. inches each (Example: 3”x 6” or larger). Installation of the vents in the mid to lower area of the enclosure is recommended. Ventilation allows for heat and or residual fuel to escape. Failure to properly vent enclosure may result in the fire-pit overheating or explosion. Overheating could lead to heat damage to internal components. Some enclosures may require more ventilation based on material, size, and extended use. The vent may work as a drain as well when installed at bottom sidewall to prevent water build up.

WARNING: The interior void space of the enclosure surrounding the valve box cannot be filled with any material (gravel, crushed rock, concrete, etc.)- It is a requirement to have a minimum of 2” under the valve box for proper ventilation and drainage.

WARNING: Select materials that are non-combustible in both initial installations as well as over time.

WARNING: The fire pit assembly should be recessed a minimum of 2.25” from the top of the enclosure to protect flame from being blown out. Some areas may require more- 4 to 6” is not uncommon.

WARRANTY REQUIREMENT: Do not daisy chain wiring for multiple Fire Pit installations. Each Fire Pit must have dedicated wiring.

WARRANTY REQUIREMENT: The enclosure must be constructed on a stable surface. The weight of the fire pit must be supported by the pan and not by any control/valve box. For electronic ignition models the control/valve box must be above grade with adequate drainage to prevent water damage to the controls inside the box.

- Make sure that the structure is level. We recommend the use of the installation collar (optional) that may be mortared into the surround.
- HPC recommends that the pan lip is recessed on trough (linear), and large round products as illustrated below. HPC cannot guarantee the lip on all of our products will be perfectly flat and will not warp due to heat.

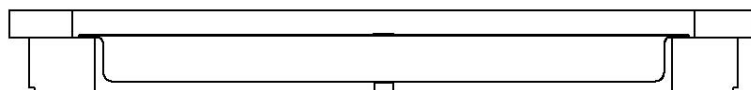

Vents- 2 Total



4) Installation of a Fire Pit

Installation

We suggest that our products be installed by professionals that are locally licensed by the authority having jurisdiction in gas piping.

WARNING: Installation and repair should be performed by a qualified service person. Fire pits should be inspected prior to initial use and annually by a qualified service person.

WARNING: Confirm this appliance is built for gas used – natural gas or LP. Do not use natural gas appliance with LP or LP appliance with natural gas. Refer to the label on the appliance.

WARNING: To prevent damage, unhook fire pit from gas supply for pressure leak tests.

WARNING: Fuel line sizing is the responsibility of the installer and must be able to supply the stated maximum btu for the product.

WARNING: Burn Testing- It is the responsibility of the qualified installer to test for gas leaks at all connections.

WARNING: When filling the pan with lava rock and/or decorative glass, the instructions in Section 5 must be followed.

WARNING: Gas Plumbing Connections: Use only joint compound or tape that is resistant to all gases. Apply joint compound to all male pipe fittings only- DO NOT use on FLARED fittings. Be sure to tighten every joint securely.

WARNING: For systems with an extended or detached valve box the area in which the valve box is installed must conform with all installation requirements to include but not limited to location, construction, venting and local codes. Failure to do so may result in personal injury property damage or explosion.

WARRANTY REQUIREMENT: Electronic Ignition fire pits come with a 13” x 13” sheet of insulation between pan and valve box to protect internal components from heat damage. This may need to be trimmed on smaller enclosures for proper fit. Please use insulation at all times.

WARRANTY REQUIREMENT: For Electronic Ignition Models the Warranty is void if valve box is opened

- Purge gas lines of air.
- Perform all leak test with leak detector or leak reactant.
- Verify correct gas type and pressure.
- Perform leak test on main gas supply. Repair leaks as necessary.
- Shut Off Gas Supply and Power to fire-pit.
- Connect fire-pit to main gas supply. If using flex line avoid sharp bends with flex line to prevent whistling.
- Turn on gas supply and perform leak test on all inlet connections. Repair as needed.
- For electronic ignition models hook up proper 110VAC or 24VAC electrical power following all local codes.
- On electronic ignition models The 6’ power cord can be either tied into the main power supply for use with wall switch or plugged into remote receiver to use remotely.
- Position fire pit safely with access to all gas connections for testing.
- Light fire pit. It may take several cycles to purge air from the lines.
 - For electronic ignition models apply proper 110VAC or 24 VAC.
- Once fire pit is lit perform leak test on all gas connections. Repair as needed.
- Turn off fire pit and allow to cool.
- Apply media as described in (Section 5).
- Turn on fire pit again and perform leak test with media correctly installed. If gas leak is detected verify correct media application and repair as needed.
- If trimmer valve is installed adjust flame to desired height. Never alter the product configuration.
- Set fire pit in properly constructed enclosure (Section 3).
- Verify correct operation and lighting.
- Review safety manual with end user and instruct not to change/ modify fire pit or media.
- Leave manual with end user.



IMPORTANT: On electronic ignition models please apply the Start Up and Shutdown decal next to control switch in an obvious position.

5) Media

WARNING: FOR GLASS MEDIA USAGE WITH LP GAS- WHEN USING APPROVED DECORATIVE GLASS TO COVER BURNER APPLY ONLY ENOUGH TO HIDE BURNER. APPLYING OVER 1/2” MAY CREATE BACK PRESSURE AND GAS LEAKAGE FROM AIR MIXER RESULTING IN LP POOLING UNDER FIRE PIT.

WARNING: FOR GLASS MEDIA USAGE WITH LP GAS- THE UNIT MUST BE TESTED WITH MEDIA OVER BURNER FOR CONFIRMATION OF NO BACK PRESSURE CREATING GAS TO LEAK OUT OF AIR MIXER VENTURI HOLES. THIS MAY HAVE TO BE DONE PRIOR TO PLACING IN ENCLOSURE IF NO ACCESS DOOR.

WARNING: The fire pit is designed to use approved media correctly installed over the burner to achieve proper combustion.

WARRANTY REQUIREMENT: Never install a mesh or screen under the media.

IMPORTANT: Media affects flame pattern greatly. It is possible to create an unusual flame pattern that could damage your enclosure. Enclosure damage from an open flame fire feature is not covered under any warranty.

Lava Rock & Glass Application

Please follow the instructions below to add the finishing touch to your fire pit. Remember the deeper your lava rock or glass the more risk of reducing if not smothering the flame. Particular attention needs to be on the pilot assembly area. Incorrect media installation will cause the pilot flame to suffocate and turn off pit or delay main burner ignition.

Lava Rock Only Application

- 1) Install your fire pit per instructions.



- 2) Apply lava rock ONLY deep enough to cover ring and pan- less than 2" above fire ring.



For Electronic Ignition

- 3) **Blow Out Box:** Do not cover vents with lava rock- leave open. Do not allow any rock to block flame opening.



- 4) **Blowout Box:** Do not cover blowout box vents or opening with lava rock or glass. Incorrect media installation will cause the pilot flame to suffocate and turn off pit or delay main burner ignition.

Decorative Glass Application

- 1) Install your fire pit per instructions.



- 2) Fill Pan with glass. Cover Burner with 1/8 to 1/4" of glass. Do not over fill with glass. All LP installations must be checked for back pressure with media installed. Failure to do so may result in personal injury or property damage.



For Electronic Ignition

- 3) **Blowout Box:** Do not cover blowout box vents or opening with lava rock or glass. Incorrect media installation will cause the pilot flame to suffocate and turn off pit or delay main burner ignition.



DO NOT COVER VENTS!



DO NOT COVER PILOT OPENING!

6) Parts Lists

- 1) Electronic Ignition Flame Control System
- 2) 120-HWI Bracket (Optional)
- 3) Instructions

7) Installation of Flame Control System

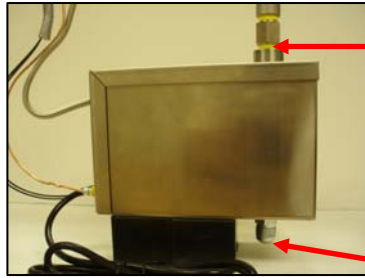

Gas Out to Main Burner

Gas In

Installation

We suggest that our products be installed by professionals that are locally licensed by the authority having jurisdiction in gas piping.

WARNING: Hard Pipe the valve box to the burner.

WARNING: Perform leak test on all fittings and back pressure checks for LP with media installed.

LP Installations:

WARNING: For LP air-mixers confirm “Gas In” is towards control valve or shutoff valve.

Installing backwards will result in severe gas leak and risk of explosion. If your air-mixer has an adjustment nut adjust to desired flame condition.

WARNING: A pan must be used on LP systems and configured in way to minimize fuel settling below the pan. Failure to do so may result in personal injury or explosion.

WARNING: For LP Installations the air-mixer should be positioned near the burner with one coupler between the burner and the air-mixer. Do not attach Air Mixer directly to burner. This may increase back pressure.

WARNING: If the Flame Control System will be extended away from the burner the air-mixer should be positioned on the burner side of the extended pipe or flex line.

WARNING: Always do thorough leak and back pressure checks on all fittings and air-mixers with media in place. This may need to be done with the fire pit outside of the enclosure.

WARNING: Never alter the unit.

WARNING: Do not put an elbow immediately after an air-mixer. This may increase the chance of back pressure.

WARNING: Never add anything after an air-mixer that would act to impeded gas flow. This may increase the risk of back pressure.

WARNING: Ensure the burner selected has sufficient flow capacity as to not create back pressure.

WARNING: Ensure correct air mixer size as described below.

40K (Standard 127LC - for use with HPC 6” Round, 36” T and smaller)

90K (Standard 127 - for use with HPC 12” Round, 12” square, 48” T and larger)

150K (Properly Sized 127 - for use with HPC 18” Round, 72” T and larger)

300K (Properly Sized 127 or 127HC with HPC 30” Round and larger)

Sizing recommendations is based on HPC burners only. Installer is responsible for correct sizing based on the application and must follow all instructions and local codes to include but not limited to back pressure checks with media.

Pilot Assembly Mounting:

WARNING: The Pilot assembly must be directly beside burner with center of pilot flame window lined up above a burner hole to ensure main burner ignition. Misalignment will cause delayed ignition of main burner.

WARNING: A pan must be used on LP systems and configured in way to minimize fuel settling below the pan. Failure to do so may result in personal injury or explosion.

WARNING: For systems with an extended valve box the area in which the valve box is installed must conform with all installation requirements and local codes. Failure to do so may result in personal/property injury or explosion.

WARRANTY REQUIREMENT: Do not touch the igniter to any metal material while energized- will blow internal fuse.

WARRANTY REQUIREMENT: If no pan is used (on natural gas systems only) accommodations must be made to protect igniter wires and thermocouple tube from flame.

IMPORTANT: For proper operation, it is required for the pilot assembly to receive fresh air from underneath.

IMPORTANT: Do not block pilot assembly blow out box underside with media (lava rock or glass)- must remain open.

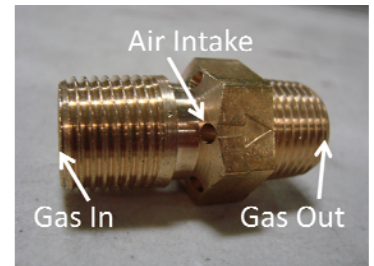

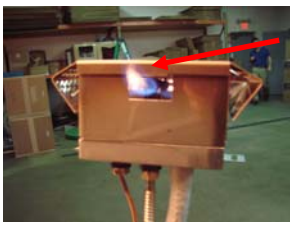

Pilot Window with flame.

Pilot Assembly

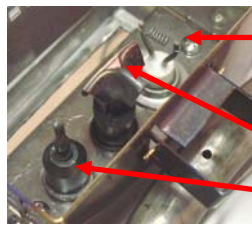

Igniter- Hot Wire
Pilot Hood
Thermocouple- flame sensing

Pilot Assembly Components

Pan Mounting:

WARNING: Pilot assembly should be directly beside burner with center of pilot flame window lined up above a burner hole to ensure main burner ignition. Misalignment will cause delayed ignition of main burner.



Pilot Window lined up with burner hole.

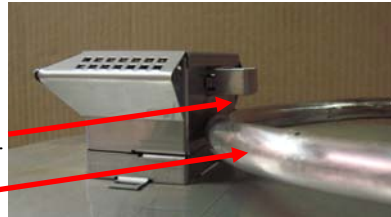

Pilot Window: Above burner.

Burner

- 1) Cut rectangular hole (2.8" x 1.75") in pan for pilot assembly mounting (see drawing below).
- 2) Drill two (2) 5/32" bolt holes for mounting of pilot assembly.



Bolt Holes (2)

Bottom View

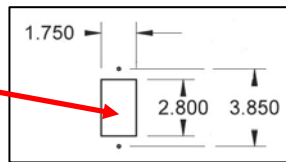

Pilot Assembly Footprint



Top View- note next to burner

IMPORTANT: Do NOT reduce rectangular hole size- must be large to prevent suffocation of pilot flame.

Burner Mounting:

The pilot assembly can also be mounted directly to the burner using our 120-HWI bracket (optional). The center portion of the T-pilot hood should be aligned with a burner hole as shown above. Care must be taken to prevent flame from being blown under the pilot assembly and damaging wire or connections.

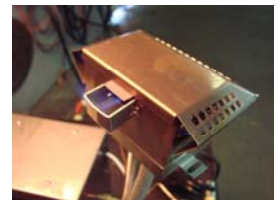

Water in Valve Prevention: HPC does not cover water in the valve under warranty.

WARRANTY REQUIREMENT: Fire Ring Drainage - If the unit will or may be exposed to rain, snow or moisture the installer must account for how water will drain out of the fire ring. If adequate ring drainage is not accomplished water will accumulate in the valve. Below is a suggestion how to provide weep holes in the ring. Drill ring and pan accordingly.

WARRANTY REQUIREMENT: Seal Center Hub – If your fire ring has a threaded center plug it is advised to seal this with a high temp sealer rated at 2000 degrees Fahrenheit or greater.

WARRANTY REQUIREMENT: Weep Holes in Pan – If not an HPC pan installer must ensure sufficient weep holes in pan to drain heavy rains positioned in a way that does not drain directly onto the valve box.

Fire Ring and Pan Weep Hole Example

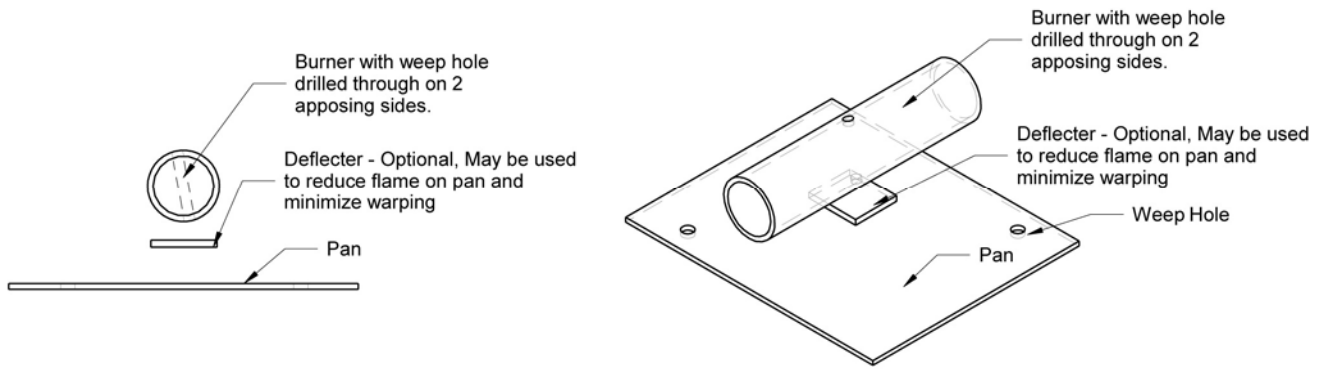

(Weep Hole Estimate For Every 10 sq. feet of pan = 10 each - 1/4" functioning weep holes)

8) Fire Pit Operation

WARNING: Before use, be sure to test all gas connections for leaks. Do not use fire pit if there is any evidence of leaking gas. If leaking gas suspected, turn off the main gas supply and repair immediately.

WARNING: Wind and gusty conditions will affect the flame in an unpredictable manner. If conditions exist that are not safe for patrons turn the fire pit off.

WARNING: Do not use fire pit if any part has been submerged under water. Immediately call a qualified service technician to inspect the fire pit.

WARNING: For electronic ignition models power to fire pit must be turned off via wall switch or breaker when not in operation.

WARNING: Never use any material that is non-porous and holds moisture such as gravel, pebbles, river rock, etc. This material, when heated will cause the trapped moisture to boil and fracture unexpectedly. This material is not sufficiently porous to allow heated steam to readily escape which can break and cause personal injury or damage.

WARNING: Solid fuels shall not be burned in the fire pit. Leaves, sticks, wood, paper, clothing, food material, should be kept away from the fire pit. Make sure that there is no vegetation or other objects over the top or sides of the fire pit that could interfere with safe operation. See clearances in section 2 Selecting the Location.

WARNING: If lava rock is wet, allow fire pit to burn for 45 minutes prior to coming within 15 feet of the fire pit.

WARRANTY REQUIREMENT: When not in use the fire pit must be covered at all times.

Electronic Ignition Fire Pit Start Up:

Initial Start-up: Several "on/off" cycles may be necessary to purge air in gas lines after system installation. Fire pit will lockout after 15 attempts to light pilot: Please power OFF then ON to restart.

Sequence of Operation:

1. The hot wire igniter will be powered (glow red) for 5 seconds before pilot valve opens.
2. The hot wire igniter will only be powered the initial 15 seconds of the 60 second pilot cycle. This sequence will repeat up to 15 times (~15 minutes) before going into lockout. To reset, turn "OFF" power then back "ON" again.
3. Pilot flame will ignite and warm thermocouple- it may take 30 seconds at times for thermocouple to get hot. If thermocouple is not hot in 60 seconds, system will shutdown then go back to Step 1.
4. Once thermocouple is hot, main valve will open allowing main burner to ignite.
5. If pilot flame is blown out at anytime, system will shutdown, then automatically restart (Step 1).

IMPORTANT: If power to the fire pit is turned "Off" then immediately turned back "On" the system will go into lockout mode. To reset, turn off, wait 5 minutes, then turn on.

FIRE PIT START UP

1. **STOP! Read the safety information on “What to Do If Smell Gas” (Pg. 1).**
2. Confirm there is no debris in fire pit (as mentioned in warnings) including water.
3. Turn “ON” electrical power and gas to fire pit.
4. Using wall switch or remote, turn “ON” fire pit- this may take several cycles to purge any air.
5. To reset after lockout, power unit down, wait 5 minutes, then restart.
6. Once fire pit has ignited, **DO NOT** leave unattended.

OVERHEATING: The fire pit will automatically close gas valve if temperature exceeds 175° F inside valve box to prevent component damage. When unit cools below 175° F, the unit will automatically restart. To correct overheating, ensure enclosure has adequate ventilation- see “Construction of Enclosure”.

FIRE PIT SHUTDOWN

1. Turn “OFF” fire pit using remote control or wall switch.

IMPORTANT: FOR REMOTE CONTROL USE: YOU MUST ALSO TURN OFF POWER TO ELECTRICAL OUTLET OR GAS TO FIRE PIT TO PREVENT ACCIDENTAL START.

2. Once fire pit is cooled, use appropriate cover to protect fire pit.

9) Maintenance

WARNING: Any guard or protective device removed for servicing must be replaced prior to operating the fire pit.

WARNING: Installation and repair should be done by a qualified service person. Fire pits should be inspected prior to use and at least annually by a qualified service person.

WARNING: Ensure gas and power (if applicable) are shut off and fire pit is cool before servicing.

- Keep fire pit covered at all times when not in use.
- Keep any debris out of fire pit- clean as needed.
- In some areas of the country spiders or insects have been known to build nest and or lay eggs in the venture holes of the air-mixer for LP units. This can cause fuel to fill the fire feature cavity and result in personal injury or property damage. Periodical inspection by a qualified service technician of the air-intake is required to ensure your fire feature performs properly.
- Ensure weep holes are clear and fire pit drains properly.
- Ring Cleaning: (1 x YR) If flames exhibit any abnormal shapes or behavior, or if burner fails to ignite properly, then the burner holes may require cleaning. The appliance can be cleaned by carefully removing the logs and media to allow access to burner. Use a brush to carefully remove dust, spider webs, and loose particles from base, logs, and fire ring itself. If evidence of damage, fire ring must be replaced with fire ring specified by manufacturer.
- Thermocouple Cleaning of Soot: (1 x 6 mos. or as needed) Remove lava rock & glass around pilot, then the blow out box lid. Clean thermocouple of any soot using soft brush. Be careful not to damage hot wire element. Place lava rock or glass back as explained in section 5.
- Visually inspect the pilot- The pilot flame should cover 3/8” to 1/2” of the thermocouple as shown below. Cleaning of orifice may be required by removing pilot hood (CCW) and removing orifice as shown below.

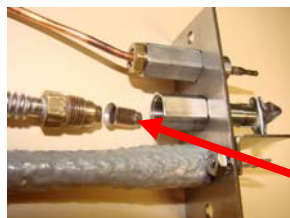
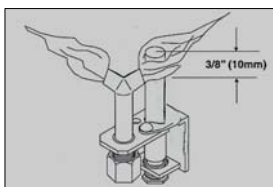

Orifice

Service
NATIONAL FIREPLACE INSTITUTE
NFI
CERTIFIED
www.nficertified.org

We suggest that our products be serviced by a professional certified in the US by the National Fireplace Institute (NFI) as NFI Gas Specialists.

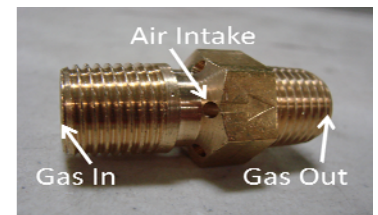

10) Troubleshooting

Below are some potential causes and countermeasures to the symptoms indicated in bold. Please contact your retailer or certified technician for service & repair.

WARRANTY REQUIREMENT: Warranty is void if valve box is opened.

Hot Wire Will Not Glow

- | | |
|-----------------------------------|---|
| 1. No power to unit. | Confirm breaker, wall switch, and remote are on (120Vac) |
| 2. Hi Limit Temp. Switch Tripping | Inadequate venting- see proper venting in “Construction of Enclosure” |
| 3. Hot wire element damaged | Change hot wire element. |
| 4. Damaged wires. | Inspect wires to hot wire- confirm insulation is in good condition and connections are tight. |

No Pilot Flame (Hot Wire Glows)

- | | |
|--------------------------|---|
| 1. Air in gas line. | If new install, may take several attempts to purge air |
| 2. Debris in gas line. | Confirm gas line is clear (insulation, dirt, plastic etc..) |
| 3. Gas Pressure Improper | Confirm proper gas pressure (Section 1) |
| 4. Pilot Orifice Dirty | Remove pilot head and clean (Section 9) |

No Main Burner (Pilot Lights)

- | | |
|-----------------------------|---|
| 1. Gas Pressure Improper | Confirm proper gas pressure (Section 1) |
| 2. Small Pilot Flame | Remove pilot head and clean orifice. (Section 9) |
| 3. Dirty Thermocouple | Clean using soft brush (Section 9) |
| 4. Fire Ring Obstructed | Confirm no debris or water in ring (Always cover fire pit!) |
| 5. Improperly applied Media | See (Section 5) |

Main Burner Turning Off/On Frequently

- | | |
|-----------------------------|---|
| 1. Small Pilot Flame | Remove pilot head and clean orifice (Section 9) |
| 2. Improperly applied Media | See (Section 5) |
| 3. Gas Pressure Improper | Gas pressure too low (Section 1) |
| 4. Thermocouple Defective | Change Thermocouple. |

11) Replacement Parts

Please see list below for replacement parts as needed. Please contact your known dealer for these parts- if unsure please contact HPC and we will be happy to help you.

Thermocouple	311-T/C
Igniter Repair Kit	HWI-913/Shield
Pilot Gas Line	654
Blow Out Box	598HWI
Insulation	FPI-13SQ
Remote Control	578-C
Lava Rock	657

12) Warranty

Limited Warranty

Hearth Products Controls Company (HPC) warranties HWI fire pits against manufacturing defects that prevent safe and correct function as follows:

- **Electronics, Gas Valve, & Pilot Assembly: Commercial-6mos; Residential- 1 yr.**
- **Stainless Steel Pan, Fire Ring, & Valve Box: Commercial-1yr.; Residential 3yrs.**

This commences from the date of original sale / shipment from HPC FOB Dayton, Ohio.

This warranty is for parts and in-house (HPC) labor. The defective product must be sent back to HPC with a Return Merchandise Authorization (RMA) issued by HPC for that specific product and any other additional information for the nature of the defect or warranty claim.

The warranty does not cover items that have been damaged by overheating, modification, abuse, or improper storage. Also any labor involving installation or maintenance with the unit is not covered.

This warranty excludes claims for consequential, indirect-collateral expenses arising from product defects or warranty recovery.

Figure 1

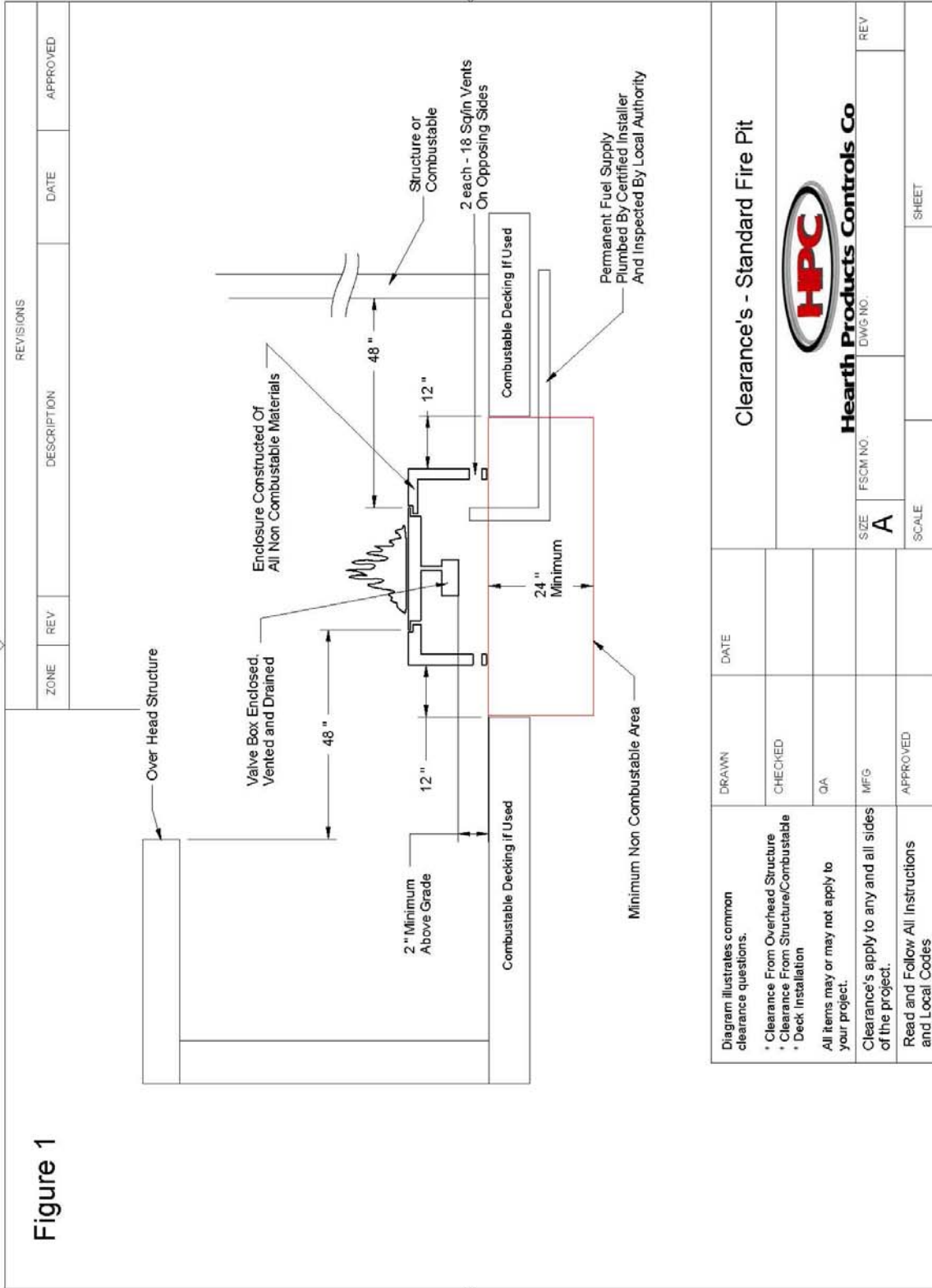

REVISIONS			
ZONE	REV	DESCRIPTION	DATE
			APPROVED

Clearance's - Standard Fire Pit



Hearth Products Controls Co
 DWG NO. _____

SIZE	FSCM NO.	REV
A		
SCALE		SHEET

Diagram illustrates common clearance questions.	DRAWN	DATE
* Clearance From Overhead Structure	CHECKED	
* Clearance From Structure/Combustible	QA	
* Deck Installation	MFG	
All items may or may not apply to your project.	APPROVED	
Clearance's apply to any and all sides of the project.		
Read and Follow All Instructions and Local Codes		

Figure 2

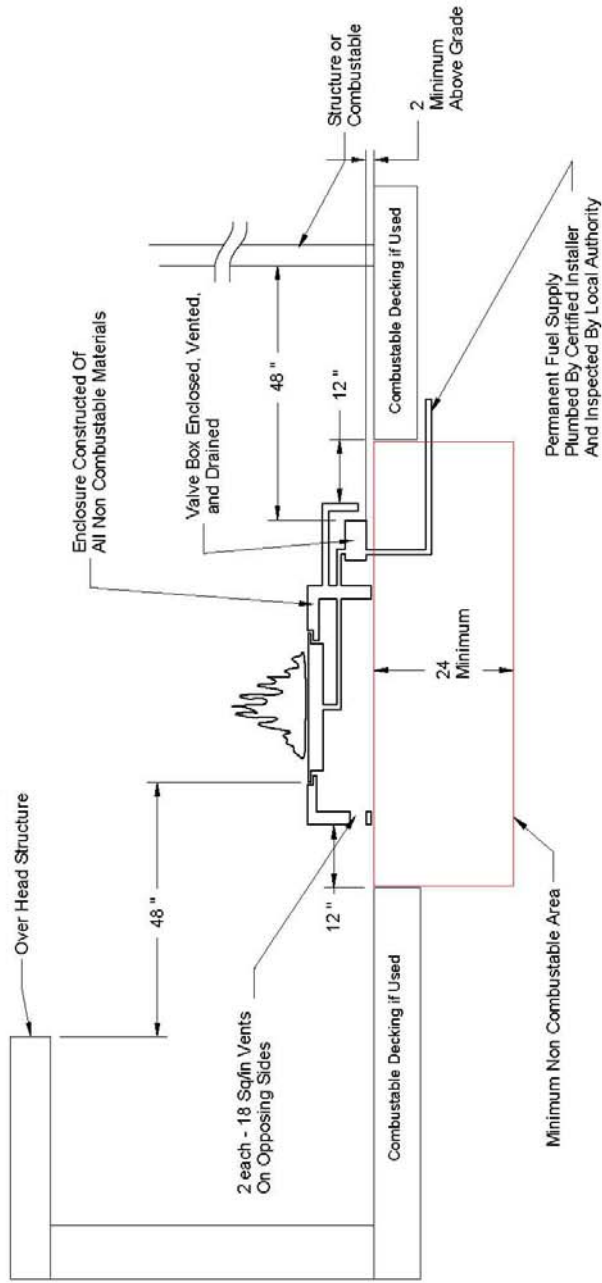

REVISIONS		DATE	APPROVED
ZONE	REV	DESCRIPTION	

Diagram illustrates common clearance questions.	DRAWN	DATE	Clearance's - Extended Valve Box	
* Clearance From Overhead Structure	CHECKED		 Hearth Products Controls Co	
* Clearance From Structure/Combustible Deck Installation	QA			
All items may or may not apply to your project.	MFG		SIZE	FSCM NO.
Clearance's apply to any and all sides of the project.	APPROVED		A	
Read and Follow All Instructions and Local Codes			SCALE	DWG NO.
				REV
				SHEET